

1. Scope of Application

This data sheet is applied to the LED package, model CL-L430-MC1L2-A.

2. Part code

$$\frac{\text{CL}}{[1]} - \frac{\text{L430}}{[2]} - \frac{\text{M}}{[3]} \frac{\text{C1}}{[4]} \frac{\text{L2}}{[5]} - \text{A} - \frac{\text{T}}{[5]}$$

[1] Part Code

[2] Special features M : General color rendering index Ra 80 minimum.

[3] Watt class C1: 1 watt class package

[4] Chromaticity range L2: Corrirated color temperature 2700K

[5] Shipping specification T : Taping

■ Features ■

- ☞ External Dimensions: 5.0×5.0×2.65 mm
- ☞ Internal Structure: Lead frame
- ☞ Luminous Flux: 109 lm @ 350 mA
- ☞ CCT: 2700 K (ANSI C78.377 Compliant)
- ☞ CRI: Ra 80 min.
- ☞ Thermal Resistance: 9 C/W
- ☞ RoHS Compliant

Symbol	CITILED
Name	CL-L430-MC1L2-A
CITIZEN ELECTRONICS CO.,LTD. JAPAN	

3. Outline drawing

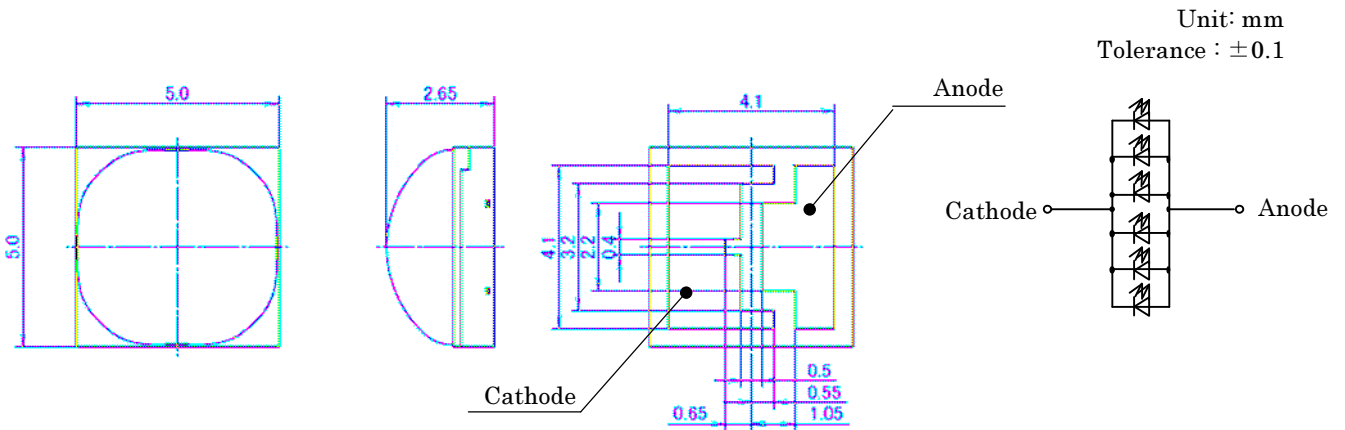

4. Performance

(1) Absolute Maximum Rating

Parameter	Symbol	Rating Value	Unit
Input Power	P _i	2.0	W
Forward Current	I _F	600	mA
Reverse Voltage	V _R	5	V
Operating Temperature	T _{op}	-30 ~ +85	C
Storage Temperature	T _{st}	-40 ~ +100	C
Solder Temperature	T _s	85	C
Junction Temperature	T _j	120	C

*1 Input power and forward current are the values when the LED is used within the range of the derating curve in this data sheet.

*2 T_s : Anode solder terminal.

*3 D.C. Current : $T_j = T_s + R_{j-s} \times P_i$

Symbol	CITLED
Name	CL-L430-MC1L2-A
CITIZEN ELECTRONICS CO.,LTD. JAPAN	

(2) Electro-optical Characteristics

$T_s=25C$

Parameter	Symbol	Condition	Min.	Typ.	Max	Unit
Forward Voltage	V_F	$I_F=350mA$	2.8	3.1	3.4	V
Luminous Flux	ϕ_v	$I_F=350mA$	82	109	-	lm
CRI	Ra	$I_F=350mA$	80	-	-	-
Thermal Resistance	R_{j-c}	Junction-Case	-	9	-	C/W

Chromaticity coordinates (Condition : $I_F=350mA$, $T_s = 25C$)

		x	y
2700K	Center	0.4578	0.4101
	a	0.4813	0.4319
	b	0.4562	0.4260
	c	0.4373	0.3893
	d	0.4593	0.3944

*The chromaticity center refers to ANSI C78.377:2008.

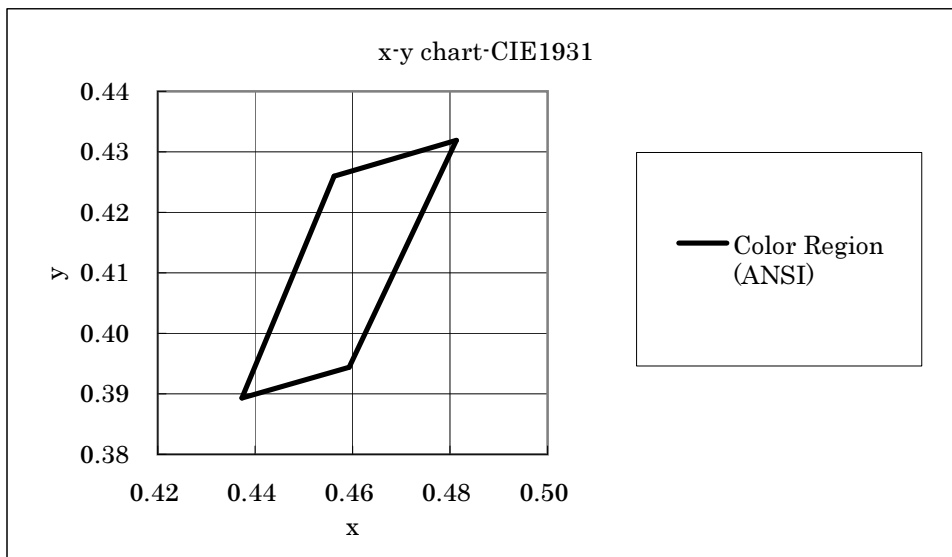

Note: The tolerance of measurement at our tester is $V_F \pm 3\%$, $\Phi_v \pm 10\%$, Chromaticity(x,y) ± 0.005 and Ra ± 1 .

Symbol	CITILED
Name	CL-L430-MC1L2-A
CITIZEN ELECTRONICS CO.,LTD. JAPAN	

5. Characteristics

•Forward Current vs. Forward Voltage

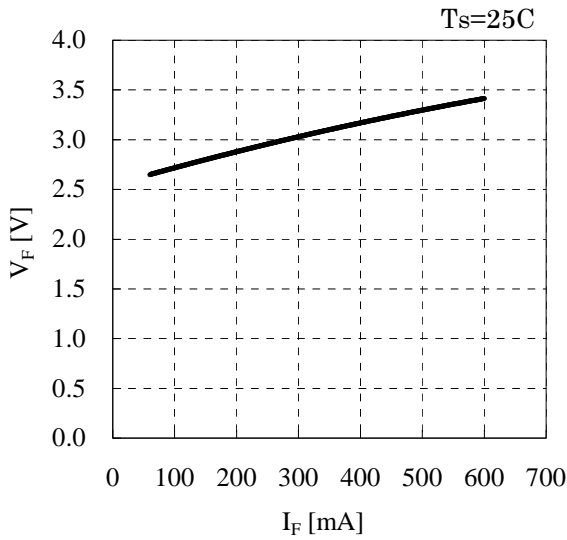

•Forward Current vs. Relative Luminous Flux

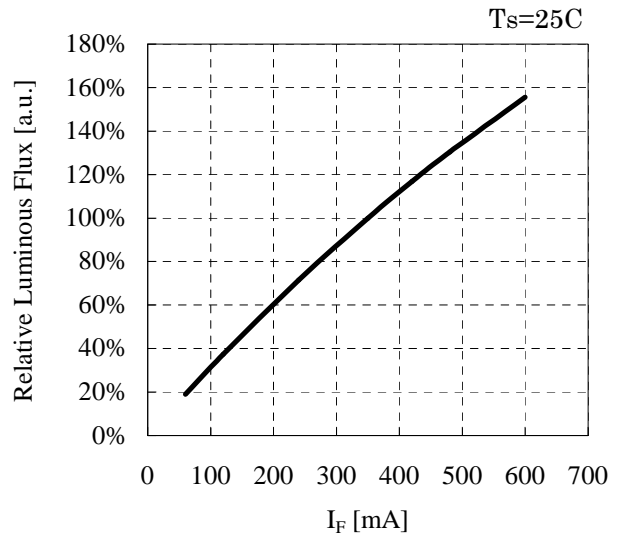

•Forward Current vs. Chromaticity Coordinate

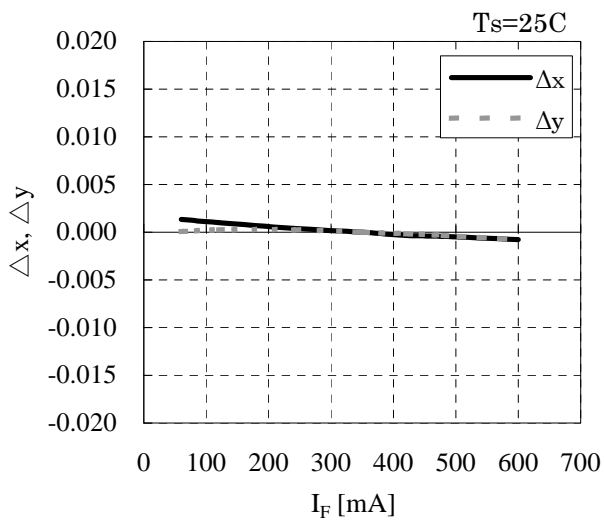

•Case Temperature vs. Chromaticity Coordinate

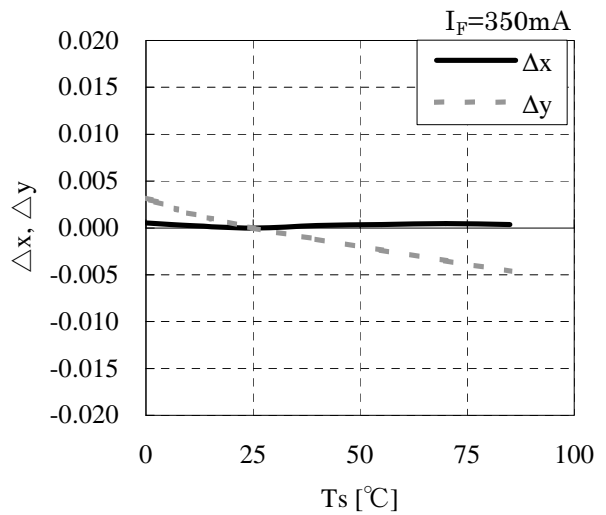

Symbol	CITLED
Name	CL-L430-MC1L2-A
CITIZEN ELECTRONICS CO.,LTD. JAPAN	

•Case Temperature vs. Forward Voltage
 $I_F=350\text{mA}$

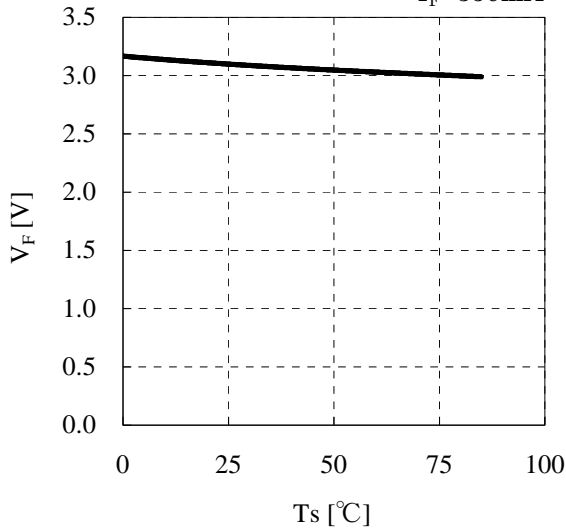

•Case Temperature vs. Relative Luminous Flux
 $I_F=350\text{mA}$

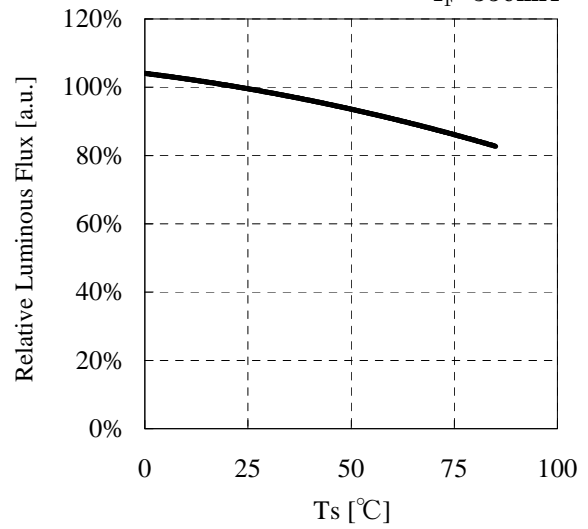

•Case Temperature vs. Allowable Forward Current •Spectrum

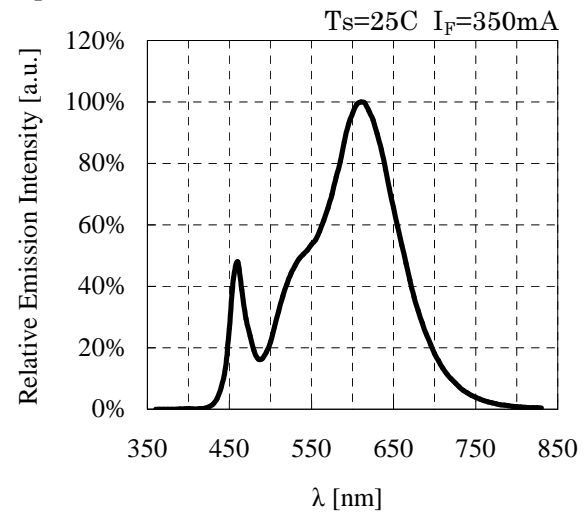
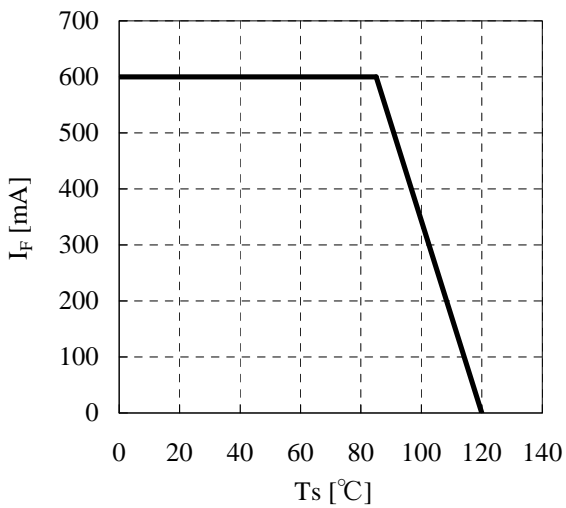

•Directive Characteristic

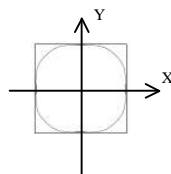
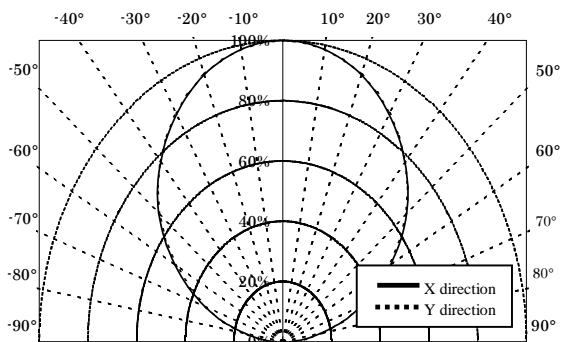

Symbol	CITLED
Name	CL-L430-MC1L2-A
CITIZEN ELECTRONICS CO.,LTD. JAPAN	

6. Reliability

(1) Details of the tests

Test Item	Test Condition
Continuous Operation Test	Ta=25 C, I _F =350mA× 1000 hours
Low Temperature Storage Test	-40 C × 1000 hours
High Temperature Storage Test	100 C × 1000 hours
Moisture-proof Test	60 C, 90 %RH for 500 hours
Thermal Shock Test	-40 C × 30 minutes – 100 C × 30 minutes, 100 cycle
Solder heat resistance test	Recommended temperature profile (reflow soldering)× 2, (2nd test must be started after the samples are stabilized thermally.)

(2) Judgement Criteria of Failure for Reliability Test (Ta=25°C)

Measuring Item	Symbol	Measuring Condition	Judgement Criteria for Failure
Forward Voltage	VF	I _F =350mA	>U X 1.1
Total Luminous Flux	φv	I _F =350mA	<S X 0.70

U defines the upper limit of the specified characteristics. S defines the initial value.

Note : Measurement shall be taken between 2 hours and 24 hours, and the test pieces should be return to the normal ambient conditions after the completion of each test.

Symbol	CITLED
Name	CL-L430-MC1L2-A
CITIZEN ELECTRONICS CO.,LTD. JAPAN	

7. Taping Specifications

(1) Dimensions of Reel

Unit : mm

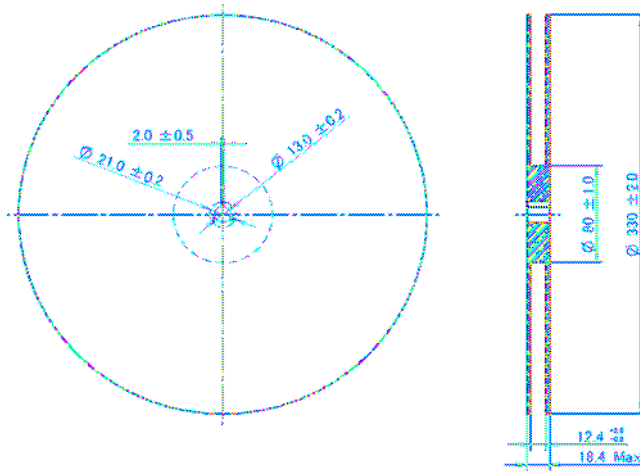

(2) Dimensions of Career tape

Unit : mm

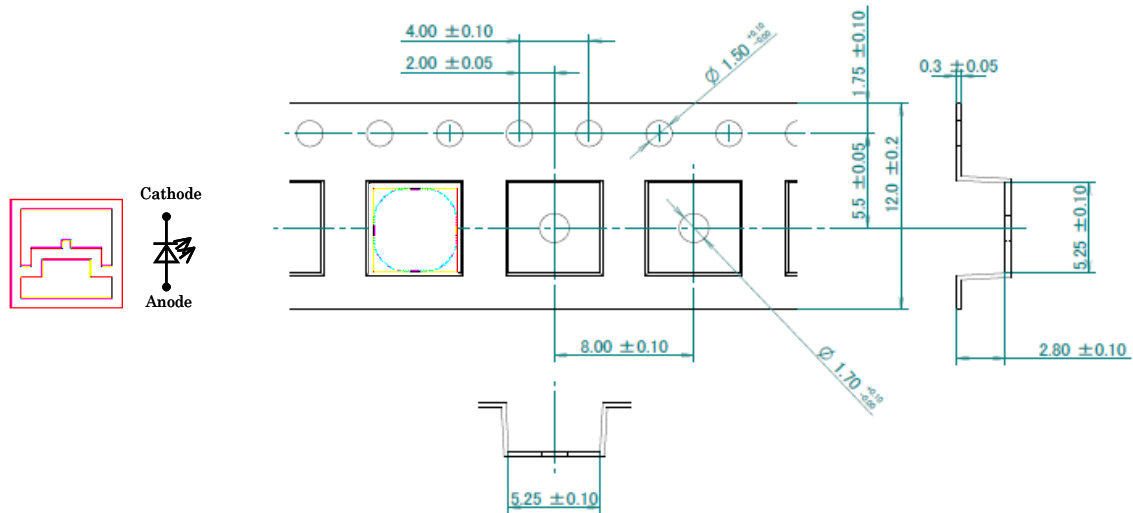

(3) Configuration of Tape

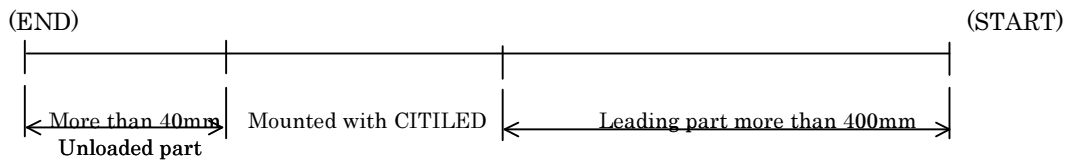

(4) Quantity 2500pcs/reel

Symbol	CITILED
Name	CL-L430-MC1L2-A
CITIZEN ELECTRONICS CO.,LTD. JAPAN	

8. Packing Specification

(1) Moisture-Proof Packing

To prevent moisture absorption during transportation and storage, reels are packed in aluminium envelopes which contain a desiccant with a humidity indicator.

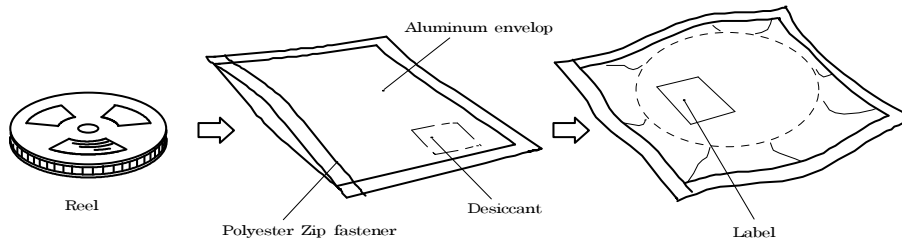

(2) Storage

To prevent moisture absorption, it is strongly recommended that reels (in bulk or taped) should be stored in the dry box (or the desiccator) with a desiccant as the appropriate storage place. If not, the following condition is recommended.

Temperature : 5~30C
Humidity : 60%RH max

The devices should be mounted within 168H(7days) after unpacking.

If you store the unpacked reels, please store them in the dry box or seal them into the envelope again.

(3) Using condition

This device contains silver plated electrode. So, when being exposed to environment which contains corrosive gases, the silver plating becomes tarnished.

Tarnished plating may lead to poor solderability and degradation of optical characteristics.

Please DO NOT expose this device to a corrosive atmosphere anytime (during storage, or after mounted). Please take care above when designing your product.

Symbol	CITILED
Name	CL-L430-MC1L2-A
CITIZEN ELECTRONICS CO.,LTD. JAPAN	

9. Precautions

1. Handling precaution

- (1). Please do not place strong pressure on the silicone dome lens.
- (2). Avoid any contact by a sharp metal nail or other materials with the silicone dome lens.

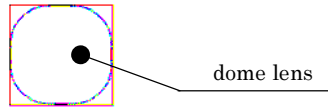

(3) Pick and Place

When mounting LEDs using automated equipment, contact pressure on the silicone dome lens should be minimized through use of such as a vacuum chuck. Please do not apply strong diagonal force to the dome lens or fatal damage will occur.

(4). PCB handling

Bending the circuit board with soldered LEDs may cause breakage of LEDs. Please take care to bow, twist, and warpage of fthe PCB.

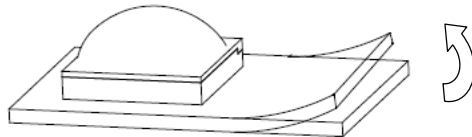

2. Lighting at low current

A minimum current value of lighting of all dice is 6mA. When a minimal current is applied, LED dice may look different in their brightness due to the individual difference of the LED element, and it is not a failed product.

3. Handling of static electricity

These products are sensitive to static electricity charge. Please take measure to prevent any static electricity being produced as the wearing of a wristband or anti-static gloves when handling this product.

All devices, equipment, and machinery must be properly grounded. It is recommended that precautions be taken against surge voltage to the equipment that mounts the LEDs.

When inspecting the final products in which LEDs were assembled, it is recommended to check whether the assembled LEDs are damaged by static electricity or not.

It is easy to find static-damaged LEDs by a light-on test.

Symbol	CITILED
Name	CL-L430-MC1L2-A
CITIZEN ELECTRONICS CO.,LTD. JAPAN	

9. Precautions (continued)

4. Designing precaution

A constant current circuit is recommended as a drive circuit.

When using two or more LED packages, connect current limiting resistor in series on each path is recommended.

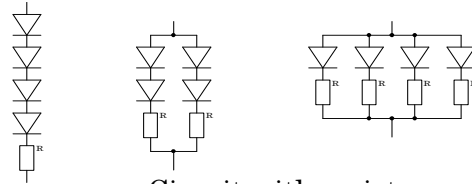

ex. Circuit with resistor.

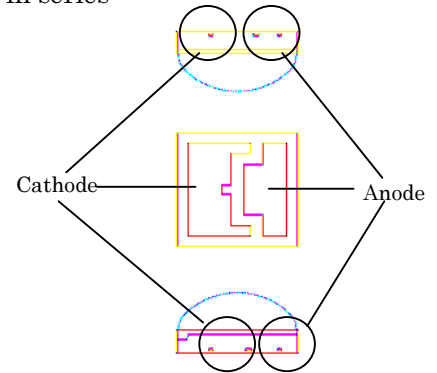

CL-L430 has small electrode at the side of package.

Please take care about shortage with conductive rubbish.

Please design a circuit that prevents any reverse voltage (excess current) from being applied to this product instantaneously when the circuit is ON or OFF.

Please be aware that this product should not come into contact with any other parts in assembled status.

5. Soldering

(1) Lead free soldering

1) Following soldering paste is recommended

Melting temperature : 216~220C.

Composition : Sn 3.5 Ag 0.75 Cu

2) The temperature profile at the top surface of the parts is recommended as below.

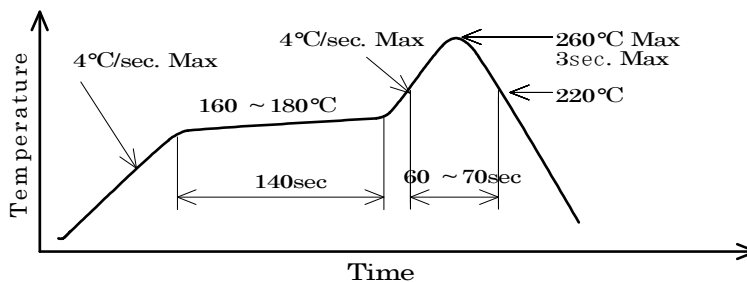

3) It is requested that products should be handled after their temperature has dropped down to the normal room temperature.

(2) Recommended soldering pattern

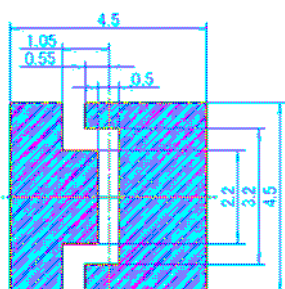

Mountability and solderability need to be optimized with actual conditions such as amount of solder, reflow temperature applied in the process.

Symbol	CITLED
Name	CL-L430-MC1L2-A
CITIZEN ELECTRONICS CO.,LTD. JAPAN	

9. Precautions (continued)

6. Heat generation

As this product is designed with consideration of the heat release property of module, a heat release design is required to use this product efficiently.
please ensure that heat generation is not in excess of the absolute maximum rating.

Factors responsible for an increase in temperature include heat generation attributed to ambient temperature conditions or power dissipation. Thus, drive condition should be taken into consideration, depending on ambient temperature(Ta).

*Citizen Electronics cannot guarantee if usage exceeds this recommended conditions.
Please use it after sufficient verification is carried out on your own risk if necessary.

7. Eye Safety

- The International Electrical Commission (IEC) published in 2006 IEC 62471 *"2006 Photobiological safety of lamps and lamp systems"* which includes LEDs within its scope. When sorting single LEDs according to IEC 62471, most white LEDs can be classified as belonging to either Exempt Group or Risk Group 1.
- However, Optical characteristics of LEDs such as radiant flux, spectrum and light distribution are factors that affect the risk group determination of the LED, and especially a high-power LED, that emits light containing blue wavelengths, may have properties equivalent to those of Risk Group 2.
- Great care should be taken when directly viewing an LED that is driven at high current, has multiple uses as a module or when focusing the light with optical instruments, as these actions may greatly increase the hazard to your eyes.
- It is recommended to regard the evaluation of stand-alone LED packages as a reference and to evaluate the customer's final product.

8. The use of Class 2 power supply is assumed for this product.

9. If the product might to be used under the following conditions, the customer must evaluate its appropriateness them. This product is not designed for use under the following conditions. in places where the product might:

- get wet due to rain
- suffer from damage caused by salt.
- be exposed to corrosive gas such as Cl, H₂S, NH₃, SO₂, Nox and so on.
- be exposed to dust, fluid or oil.

Symbol	CITILED
Name	CL-L430-MC1L2-A
CITIZEN ELECTRONICS CO.,LTD. JAPAN	

10. Precautions with regard to product use

1. This document is provided for reference purposes only so that CITIZEN ELECTRONICS' products are used as intended. CITIZEN ELECTRONICS neither makes warranties or representations with respect to the accuracy or completeness of the information contained in this document nor grants any license to any intellectual property rights or any other rights of CITIZEN ELECTRONICS or any third party with respect to the information in this document.

2. All information included in this document such as product data, diagrams, charts, is current as of the date this document is issued.
Such information, however, is subject to change without any prior notice.
Before purchasing or using any CITIZEN ELECTRONICS' products listed in this document, please confirm the latest product information with a CITIZEN ELECTRONICS' sales office, and formal specifications must be exchanged and signed by both parties prior to mass production.

3. CITIZEN ELECTRONICS has used reasonable care in compiling the information included in this document, but CITIZEN ELECTRONICS assumes no liability whatsoever for any damages incurred as a result of errors or omissions in the information included in this document.

4. Absent a written signed agreement, except as provided in the relevant terms and conditions of sale for product, and to the maximum extent allowable by law, CITIZEN ELECTRONICS assumes no liability whatsoever, including without limitation, indirect, consequential, special, or incidental damages or loss, including without limitation, loss of profits, loss of opportunities, business interruption and loss of data, and disclaims any and all express or implied warranties and conditions related to sale, use of product, or information, including warranties or conditions of merchantability, fitness for a particular purpose, accuracy of information, or no infringement.

5. Though CITIZEN ELECTRONICS works continually to improve products' quality and reliability, products can malfunction or fail. Customers are responsible for complying with safety standards and for providing adequate designs and safeguards to minimize risk and avoid situations in which a malfunction or failure of a product could cause loss of human life, bodily injury or damage to property, including data loss or corruption.
In addition, customers are also responsible for determining the appropriateness of use of any information contained in this document such as application cases not only with evaluating by their own but also by the entire system.
CITIZEN ELECTRONICS assumes no liability for customers' product design or applications.

6. Please contact CITIZEN ELECTRONICS' sales office if you have any questions regarding the information contained in this document, or if you have any other inquiries.

CITIZEN Micro HumanTech is a registered trademark of Citizen Holding Co., Japan.

CITILED is a registered trademark of CITIZEN ELECTRONICS CO., LTD. Japan

Symbol	CITILED
Name	CL-L430-MC1L2-A
CITIZEN ELECTRONICS CO.,LTD. JAPAN	